

Waterfree Cartridge Kit

Installation & Operating Instruction Manual

Thoroughly read this instruction booklet before using Sloan products.

Keep this **Installation & Operating Instruction Manual** with other product information for future reference.

WES-150 Waterfree Cartridge Kit

Cartridge Kit Includes:

- Cartridge (1)
- Cartridge Key (1)
- Sealant Package (1)
- Disposal Bag (1)
- Protective Glove (2)

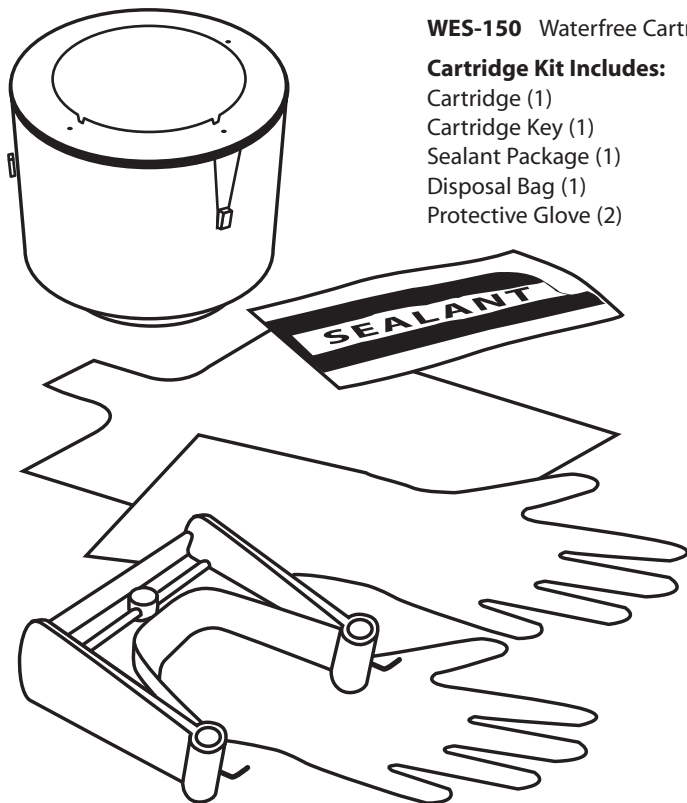

Table of Contents

	Page
Removal and Installation of Cartridge	2-3
Cartridge Sealant Instructions	3
Care and Cleaning	4

REMOVAL OF OLD CARTRIDGE

Replace cartridge every 3 months or 7,000 uses depending on usage

Step 1

Pour a quart (liter) of water into Cartridge to flush it. Insert Key into the Cartridge and turn counterclockwise.

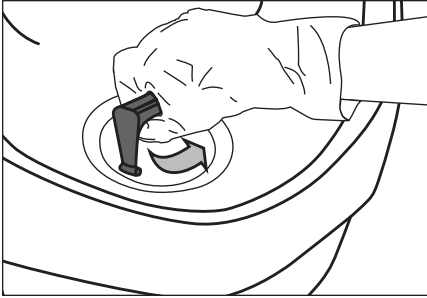

Step 2

Extract the Cartridge by pulling up on the Key. Tilt the Cartridge in the housing to drain contents.

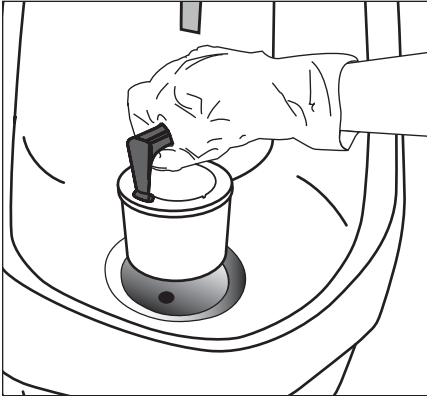

Step 3

Open the yellow Disposal Bag, keeping the Cartridge upright. Insert it into the Disposal Bag.



Step 4

Close the bag, tie the tabs together and dispose of it properly or return recyclable unit to Sloan (see www.sloanvalve.com for details).



CARTRIDGE INSTALLATION

Step 1

Before inserting Cartridge, pour a gallon of clean, hot soapy water into Housing to flush it. Use hose if available.

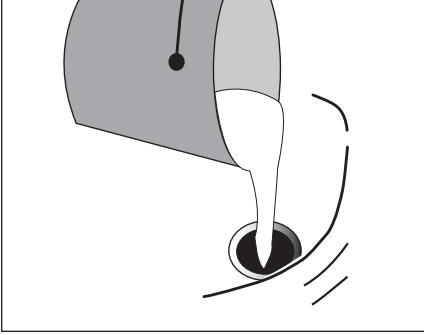

Step 2

Insert the Cartridge into the housing with the logo at the 11 o'clock position.

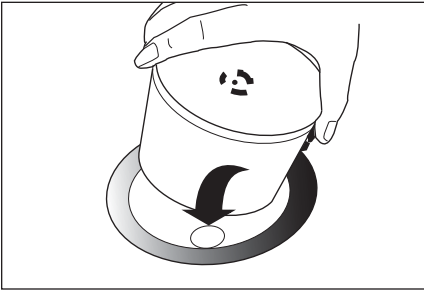

Step 3

Insert the Key into the top of Cartridge and turn the Cartridge clockwise to the 12 o'clock position to lock it in place. Remove the Key.

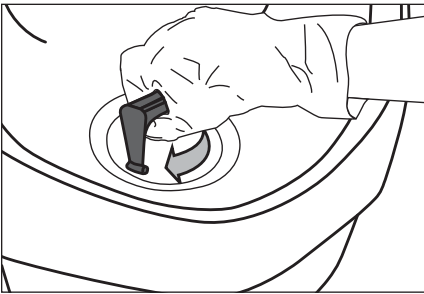

FILL CARTRIDGE

Step 1

Pour half quart (half liter) or 1 pint of water into the newly installed Cartridge.

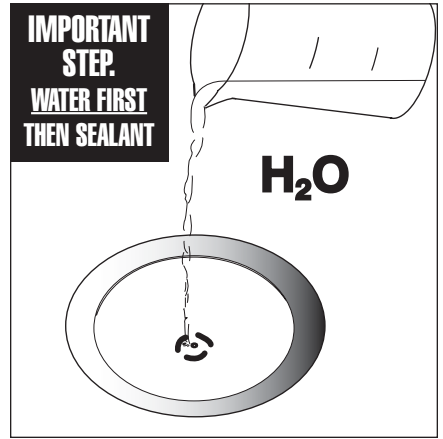

Step 2

Remove the Sealant package from the box and tear off the top.

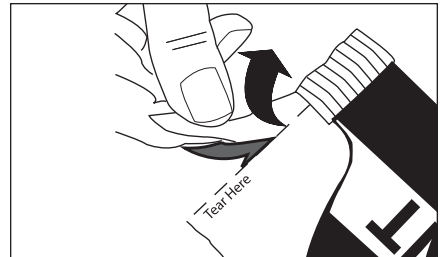

Step 3

Pour Sealant into the Cartridge drain opening, wipe off excess Sealant and attach shield. The urinal is now ready for use.

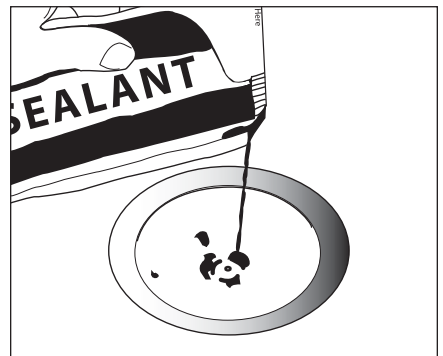

CARE AND CLEANING

Step 1

Remove all debris from the surface of the urinal.

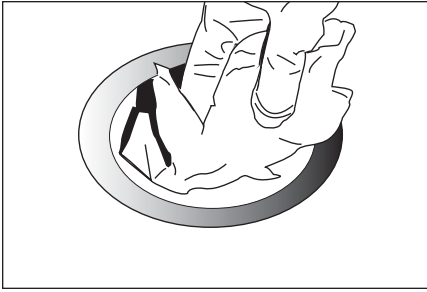

Step 2

Spray Urinal surface lightly with a mildly acidic, non-degreaser, disinfectant liquid cleaner. For a list of approved cleaners for vitreous china, visit www.sloanvalve.com/182_245.htm.

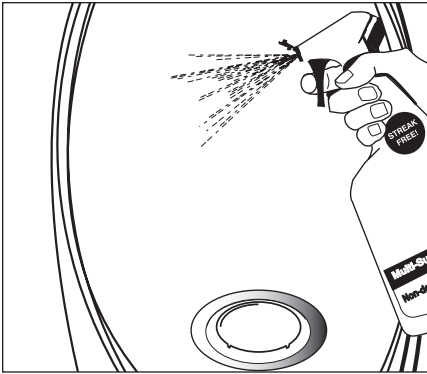

Step 3

Wipe surface with a soft cloth or sponge applicator until clean.

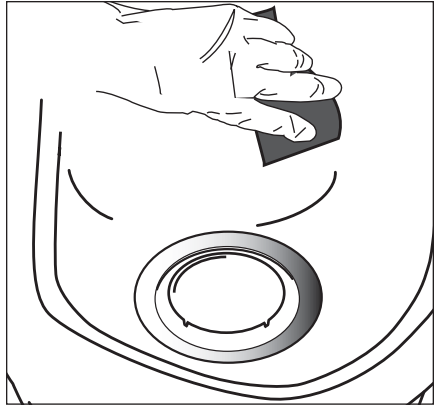

DO NOT DUMP BUCKETS OF WATER INTO URINAL WITH CARTRIDGE INSTALLED

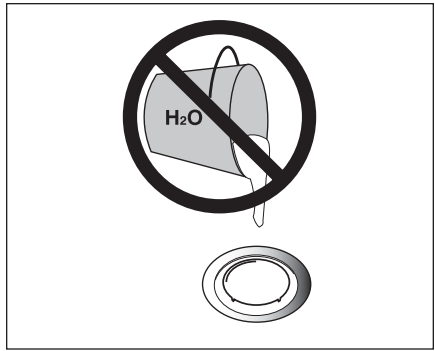

SLOAN®

TMS **EQUIPARTS**
NORTHEAST

TOLL FREE: 800-442-6622

PITTSBURGH: 412-781-9100

www.equiparts.net

That Hard to Find Part is Right Here !

©2009 Sloan Valve Company

Printed in the U.S.A. JSD6035.1 01/09